



# Finite element method (FEM1)

Lecture 2D. Examples of FE analyses

03.2025

# Division of Strength of Materials and Structures – Research Areas

## Biomechanics

- **IMPLANTS AND BONE REMODELING (SPINAL DISC IMPLANTS, HIP IMPLANTS)**

### Hip implants

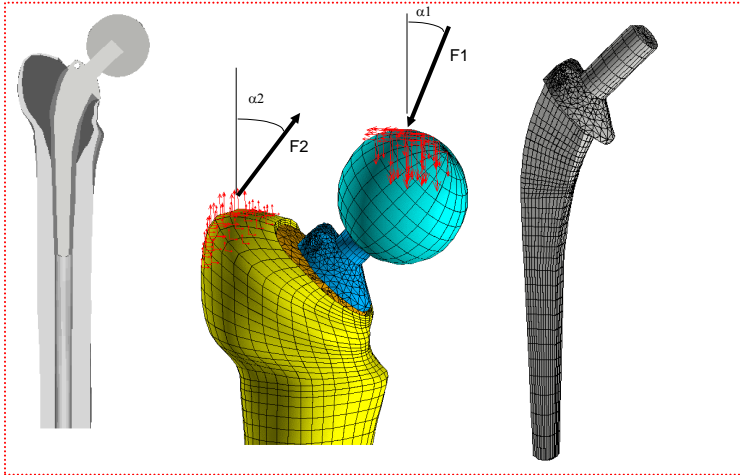

### Bone remodeling

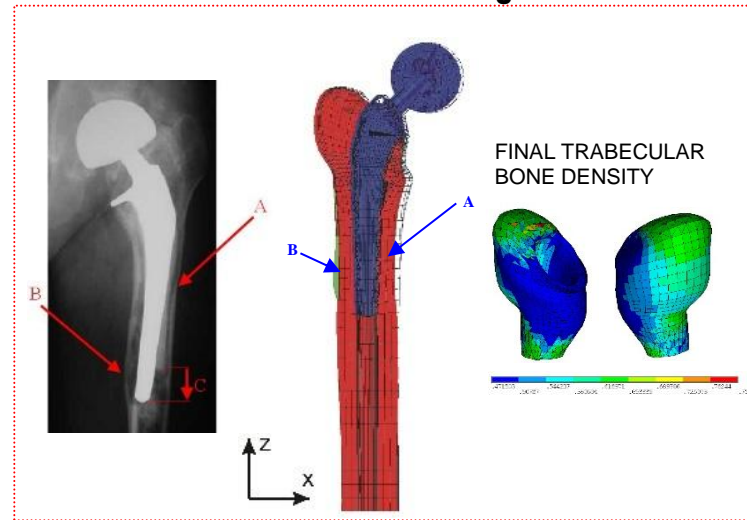

### Spine stabilization

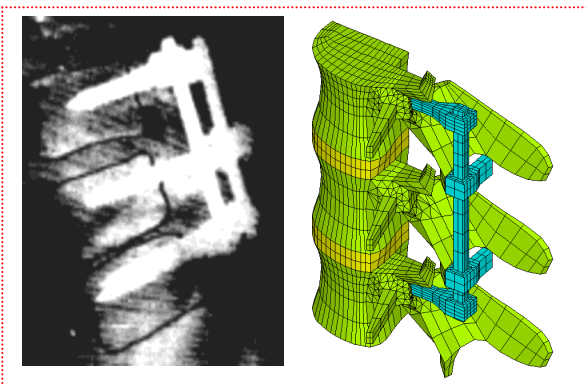

### Disc implants (NCBiR, 2010 – 2013)

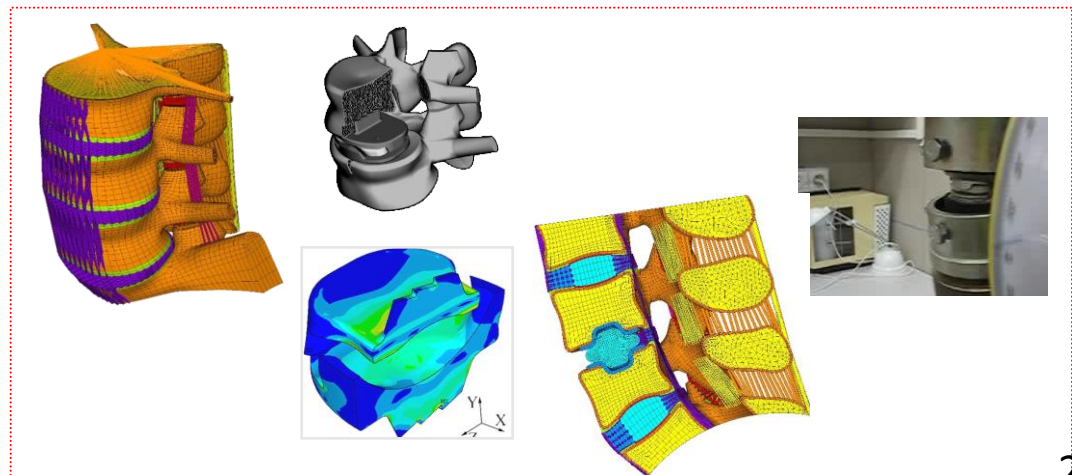

## Biomechanics

- **IMPLANTS AND BONE REMODELLING (DENTAL IMPLANTS)**
- **FINITE ELEMENT MODELS FOR NUMERICAL SIMULATION OF PLATE STABILIZATION OF MANDIBLE FRACTURE**
  - Optimization of the stabilization technique and procedure
  - Simulation of the behaviour of the bone tissue during healing period
  - Cooperation with Medical Univeristy of Warsaw

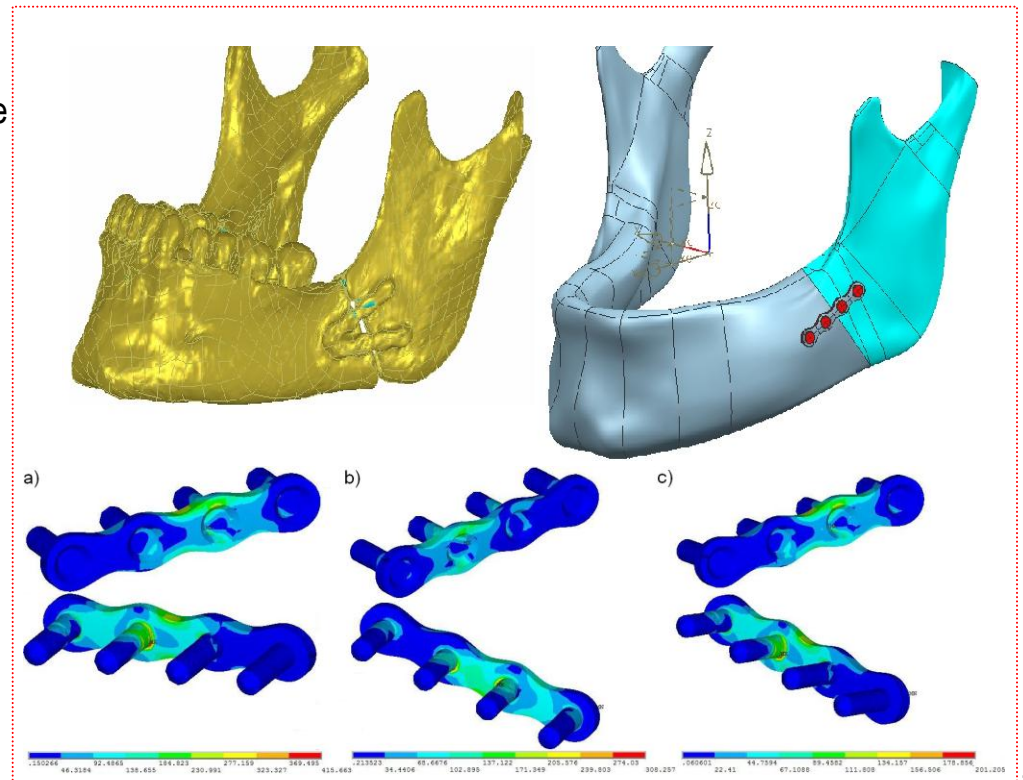
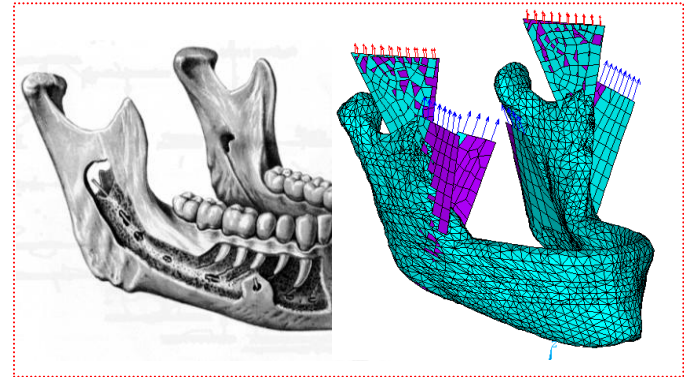

# Division of Strength of Materials and Structures – Research Areas

## Biomechanics

- **INNER EAR BIOMECHANICS AND BONE CONDUCTION IMPLANTS**

### Biomechanics of Stapedotomy Surgery – Model and Experiment (2013-2016)

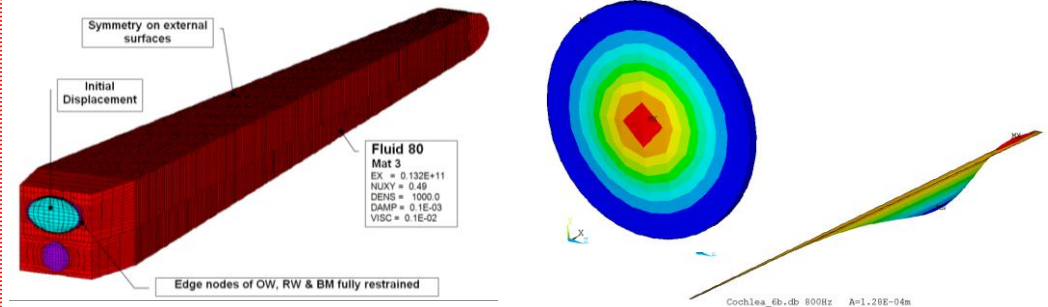

### A new innovative method for direct stimulation of inner ear structures via bone conduction (2015-2018)

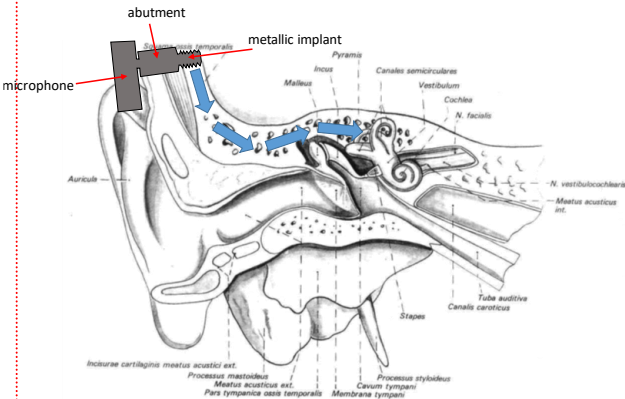

[Bochenek A., Anatomia człowieka]

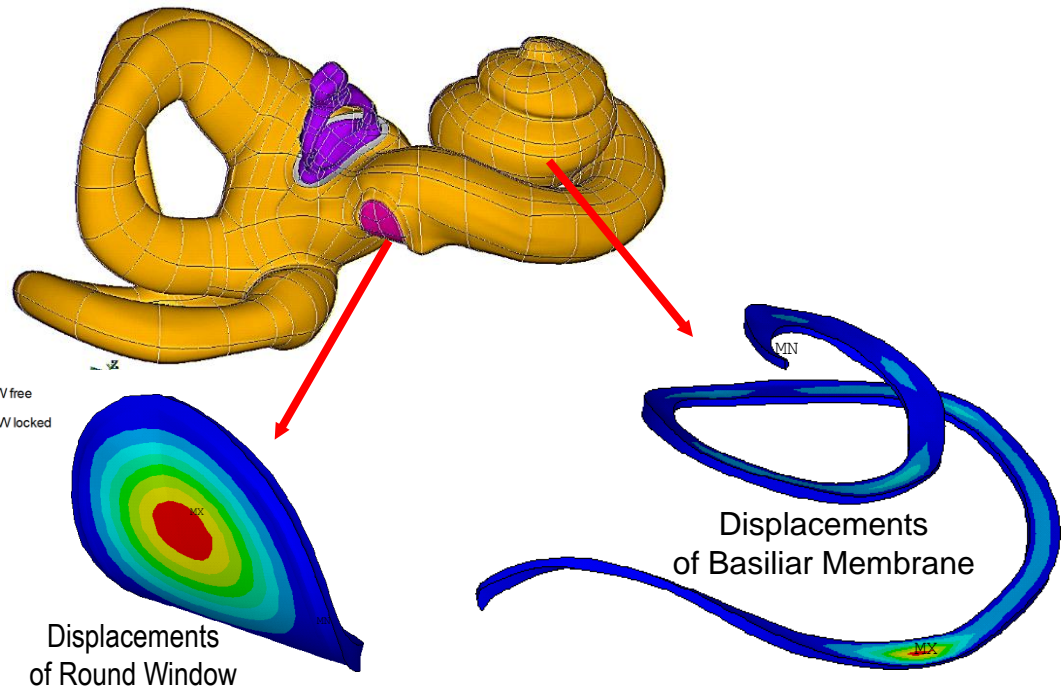
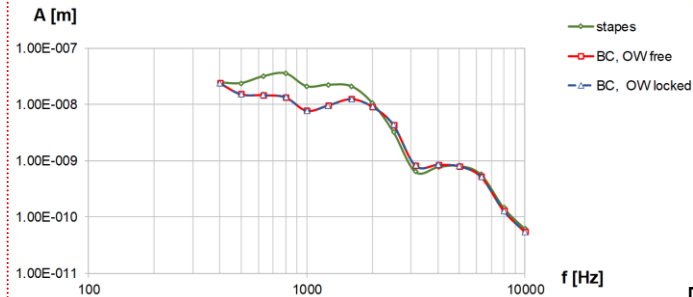

# Division of Strength of Materials and Structures – Research Areas



## Power engineering

### • FE ANALYSIS OF A HIGH PRESSURE T-CONNECTION

### • FATIGUE LIFE DEVICES IN CONDITIONS OF CYCLIC PRESSURE CHANGES (HOG -ORLEN S.A.)

### • LOW CYCLE FATIGUE PROBLEM FOR DOUBLE TUBESHEET OF QUENCH HEAT EXCHANGERS FOR ETHYLENE CRACKING FURNACES (Olefins II PKN ORLEN S.A.)

### • TIGHTNESS ANALYSIS FOR QUENCH HEAT EXCHANGERS FOR ETHYLENE CRACKING FURNACES (PKN ORLEN S.A.)

### • ANALYSIS OF FLANGE CONNECTIONS UNDER VARYING THERMAL CONDITIONS

### • ANALYSIS OF STEAM LEAKAGE IN THE FUSELAGE OF WP TURBINE (ALSTOM)

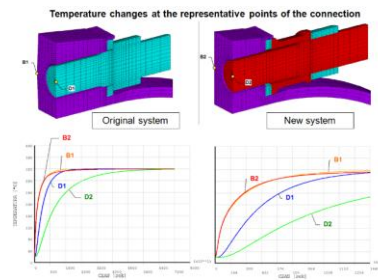
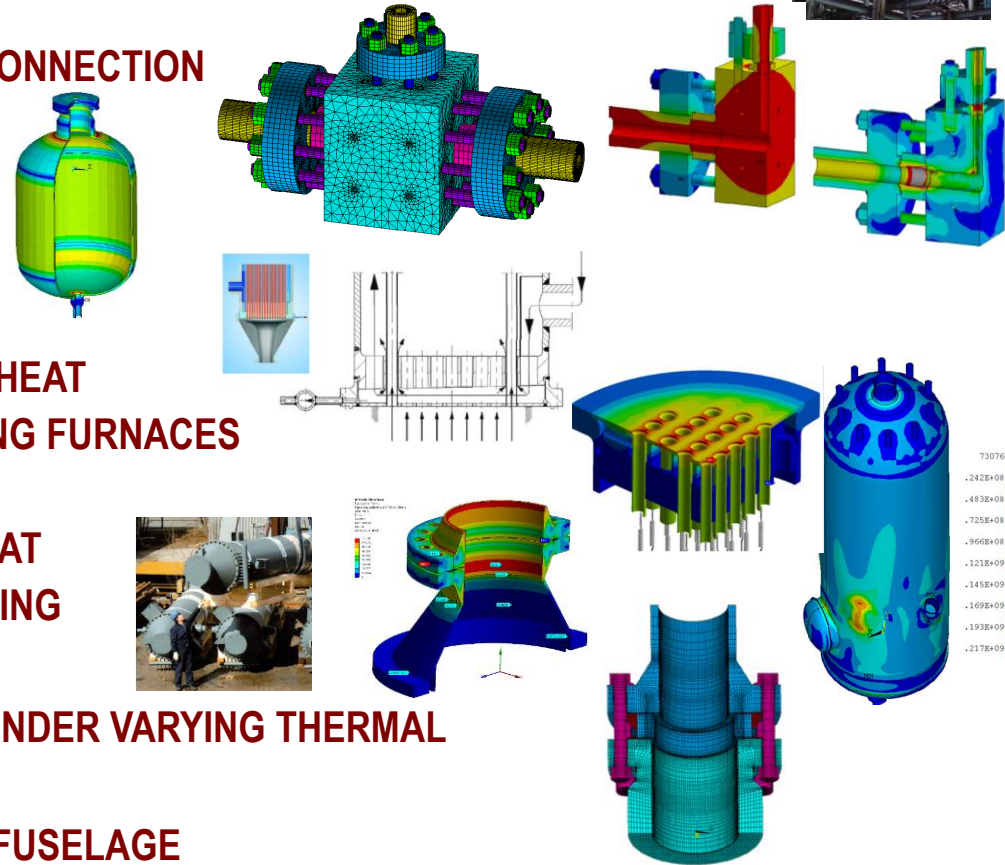

Pretension load changes vs time – different scenario

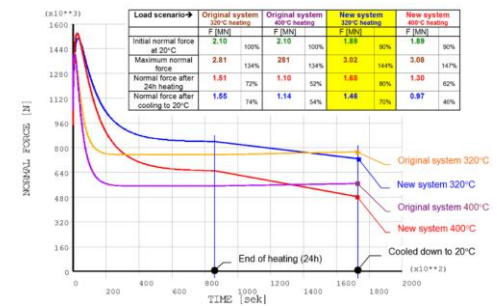

# Division of Strength of Materials and Structures – Research Areas

## Power engineering

### • PROBLEMS OF STRENGTH OF ROTATING TURBOMACHINERY

(NCBiR 2013-2015)

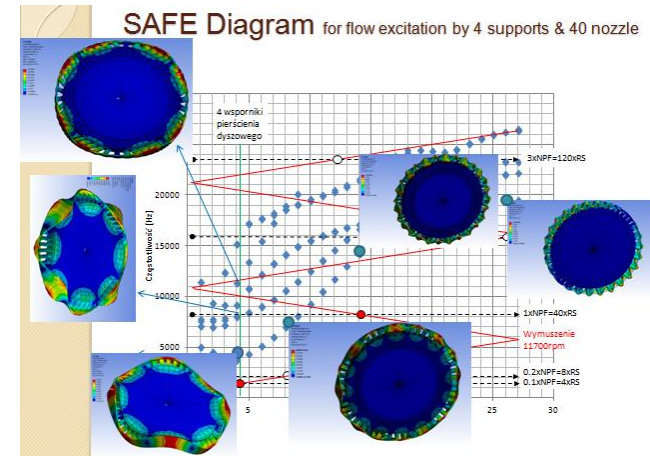
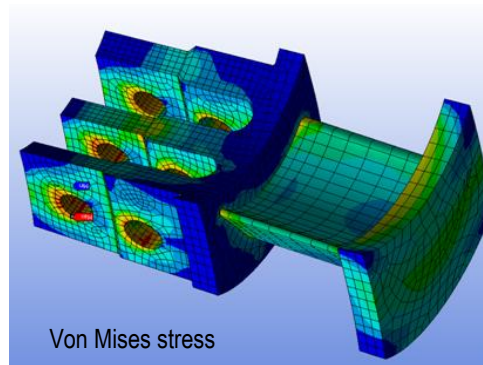
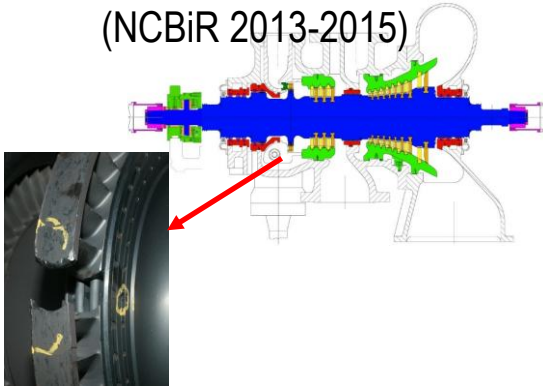

### • ANALYSIS OF THE DYNAMICS AND STRENGTH OF THE ROTORS (NCBiR 2013-2015)

Temperature distribution

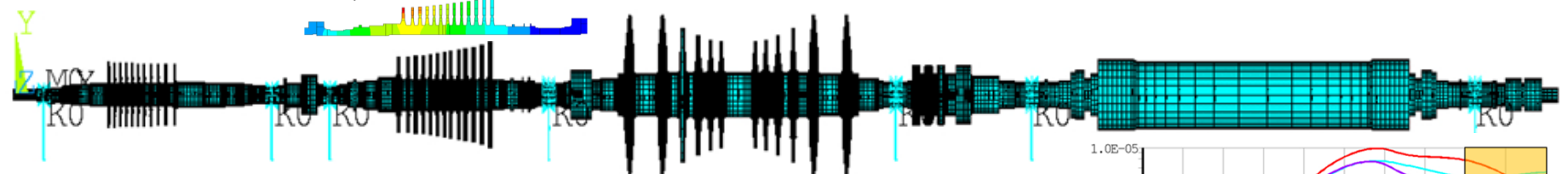

Harmonics of imbalance

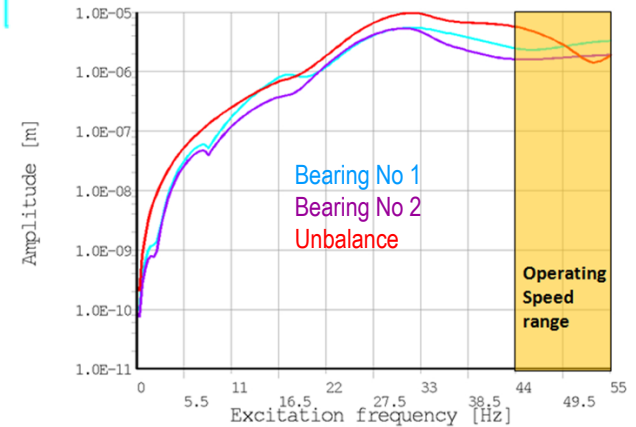
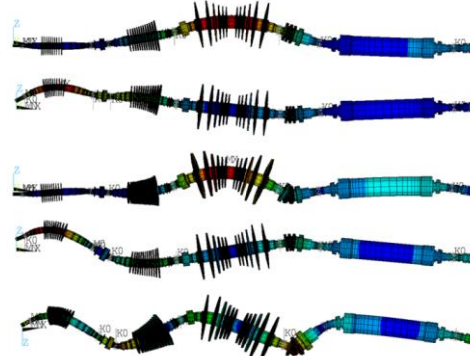

# Division of Strength of Materials and Structures – Research Areas

## Power engineering

- **FINITE ELEMENT MODELING OF MATERIAL FATIGUE AND CRACKING PROBLEMS FOR STEAM POWER SYSTEM HP DEVICES EXPOSED TO THERMAL SHOCKS (2014-2015)**

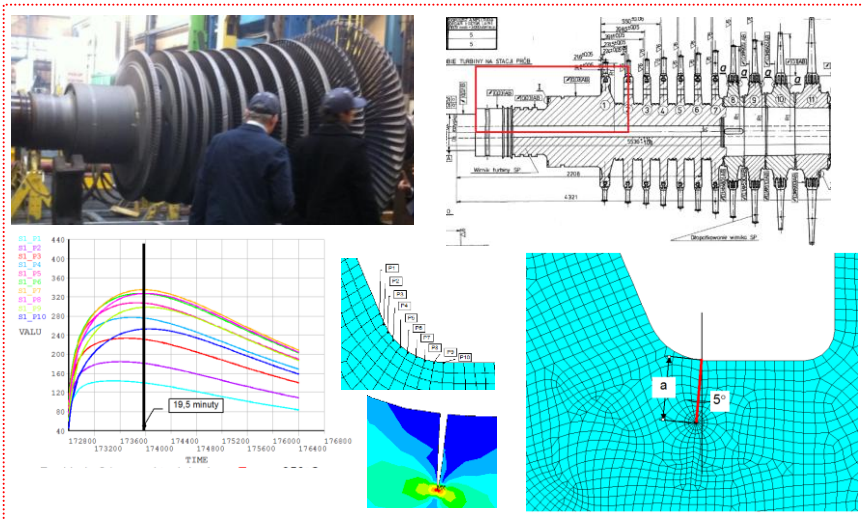

- **FE ANALYSIS OF THE TURBINE BLADE LOCKING PIECE DEFECTS**

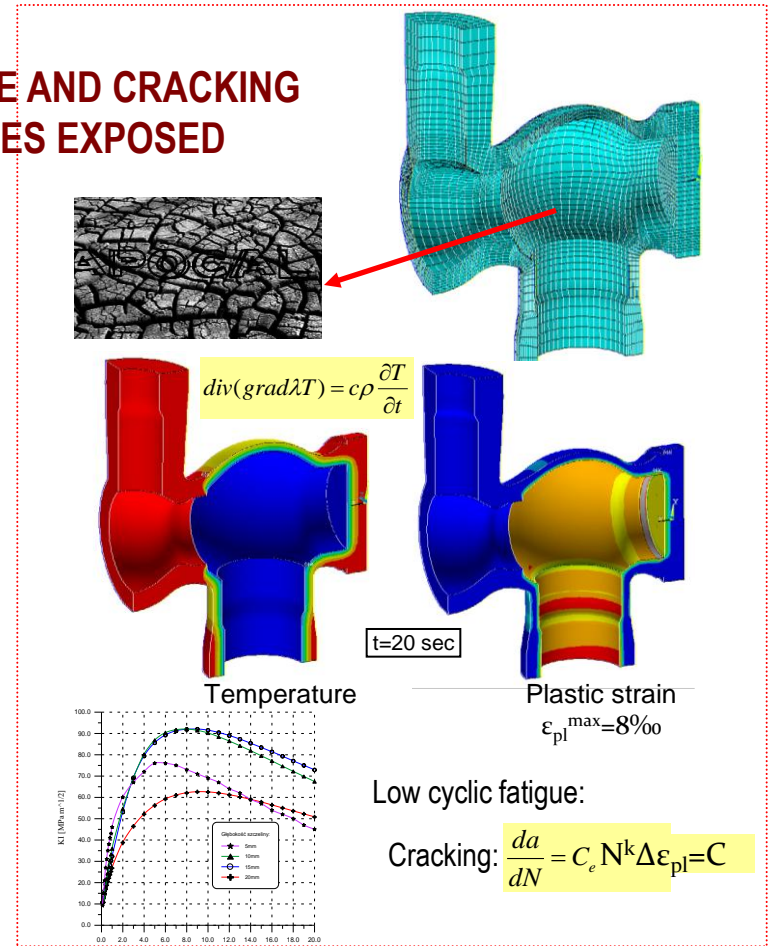
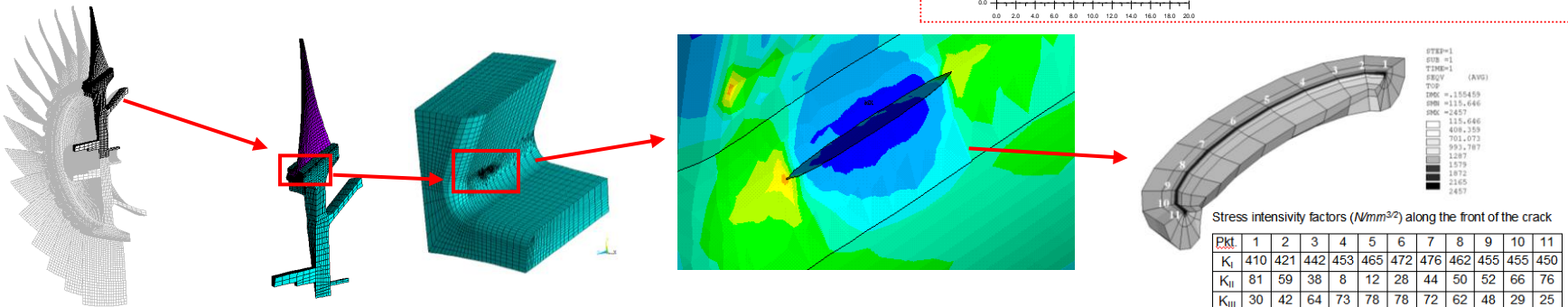

# Division of Strength of Materials and Structures – Research Areas

## Power engineering



- **FINITE ELEMENT ANALYSIS OF CRITICAL CENTRAL CONNECTION ELEMENTS OF W7-X STELLATOR COIL SUPPORT SYSTEM** (IPP, Greifswald, 2005-2011)

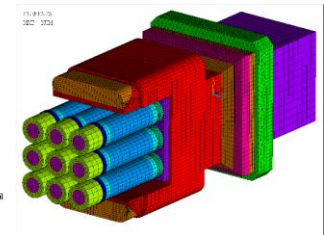
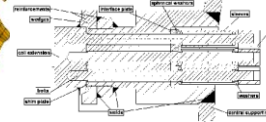
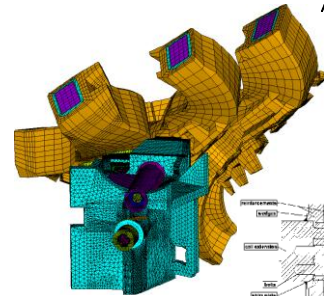
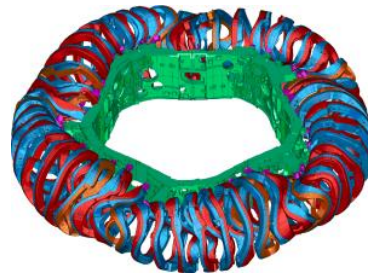

- **FE MODELLING OF THE MECHANICAL BEHAVIOUR OF SEPARABLE FIRST WALL ELEMENTS FOR ITER** (IPP, Garching, 2008)

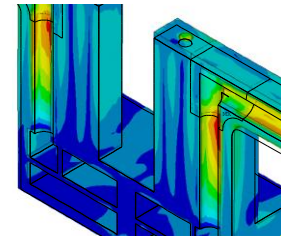
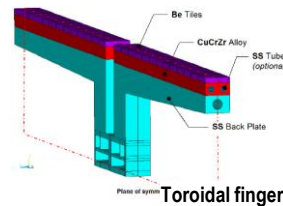
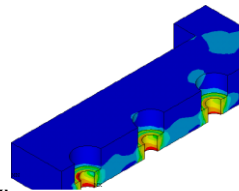
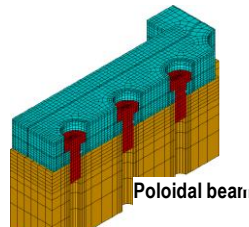
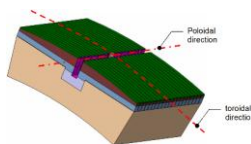
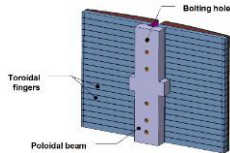

- **PRELIMINARY MECHANICAL ANALYSIS OF BLANKET MANIFOLD CONCEPT FOR ITER REACTOR** (IPP, Garching, 2008)

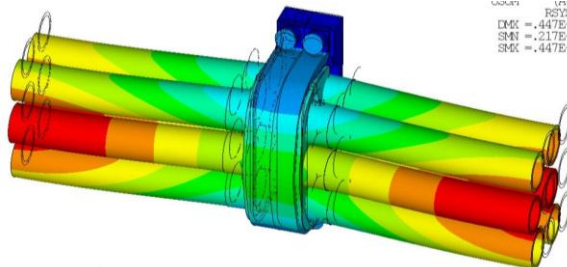

UNITS: MPa  
 DMX = .447E+01  
 SMN = -.217E+01  
 SMX = .447E+01

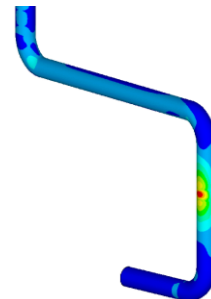

SEQV (PowerGraph)  
 EFACET=1  
 AVRES=Mat  
 DMX = .31  
 SMN = 0  
 SMX = 73.55  
 0  
 8.18  
 16.35  
 24.52  
 32.69  
 40.86  
 49.04  
 57.21  
 65.38  
 73.55

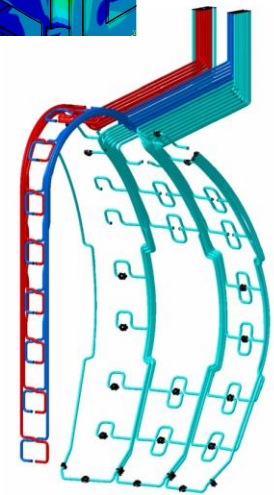



# Division of Strength of Materials and Structures – Research Areas

## Power engineering



## Structures of DEMO fusion reactor (2014-2018)

### DESIGN INVESTIGATIONS OF CRYOSTAT TOP LID FOR DEMO (2014)

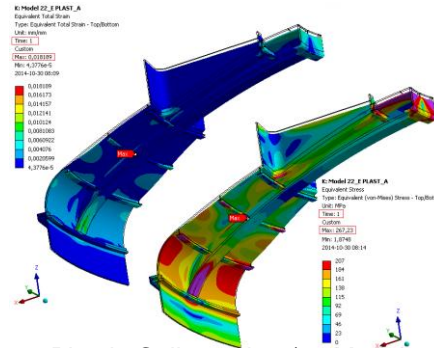
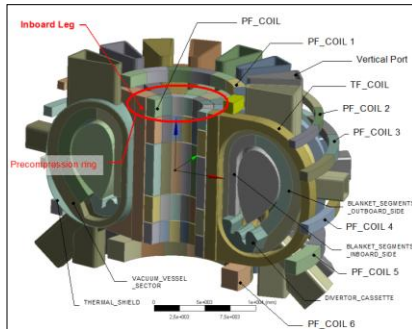

Plastic Collapse in 1/16 Model

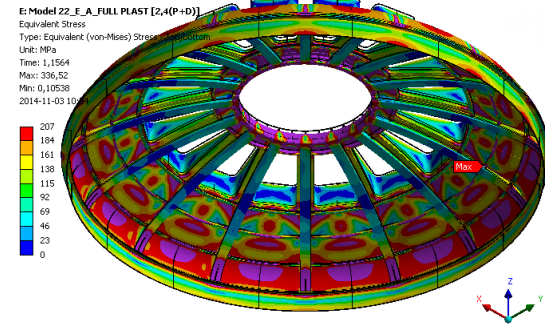

Plastic Collapse in FULL Model

### CRYOSTAT PEDESTAL RING DESIGN ASSESSMENT (2015)

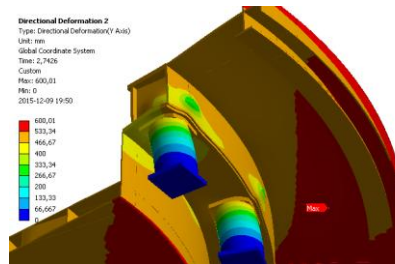
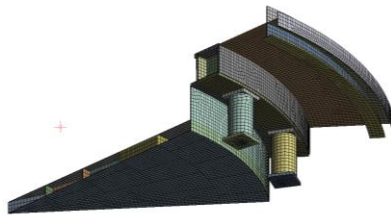

UY displacements (LF=2.7426)

### STRUCTURAL ANALYSES OF VARIOUS TF COIL CONFIGURATIONS (2016)

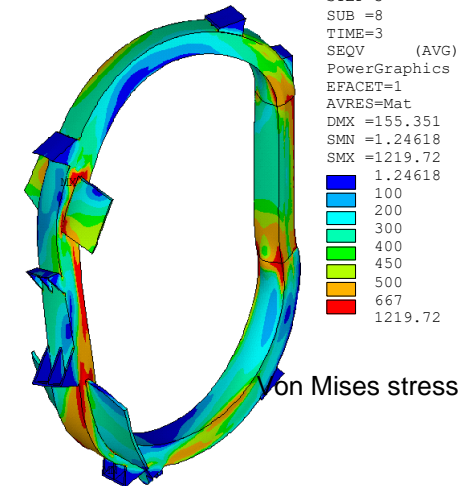

von Mises stress

### DESIGN AND ANALYSIS OF BIOSHIELD ROOF (2016)

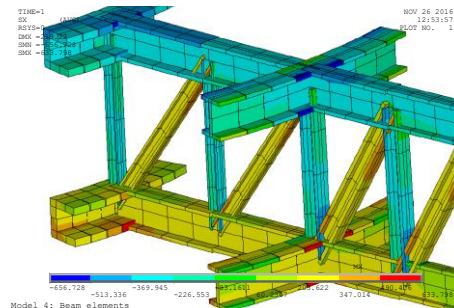
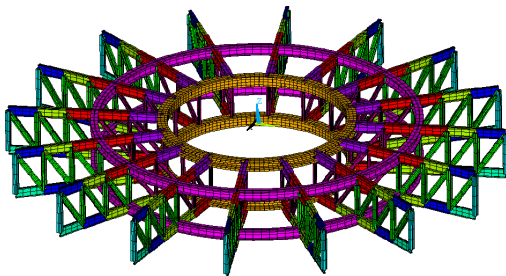

# Division of Strength of Materials and Structures – Research Areas

## Composites, cellular solids, smart and intelligent materials

- **Structural Optimization :**

**THE PREDICTION OF OPTIMAL MATERIAL LAYOUT AND PROPERTIES FOR ELASTIC CONTINUUM STRUCTURE USING WEIGHTED RESOURCE CONSTRAINT (UoM- PW 1997-2008)**

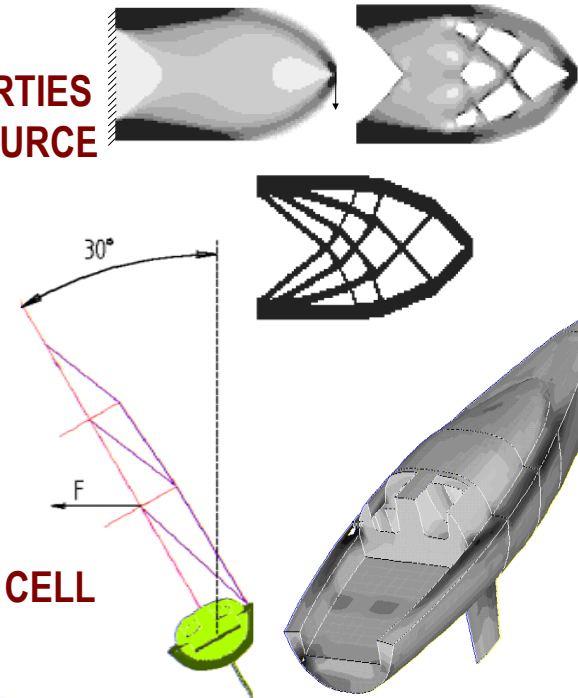
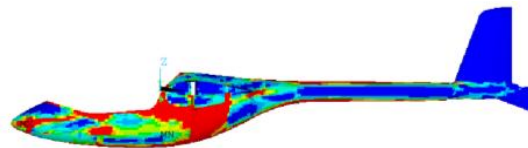
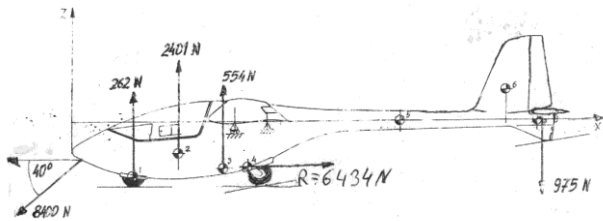

- **Mechanics of Cellular Solids:**

**MECHANICAL PROPERTIES OF LOW DENSITY OPEN & CLOSED CELL FOAMS BASED ON TETRAKAIDECAHEDRONAL MODEL OF MICROSTRUCTURE Aluminium Foam (AlSi12Mg1) (UoM PW MEiL +WIM - 1997-2017)**

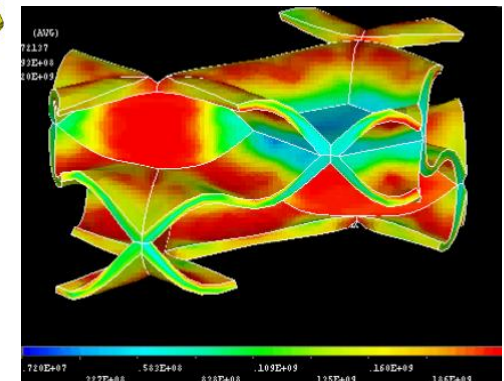
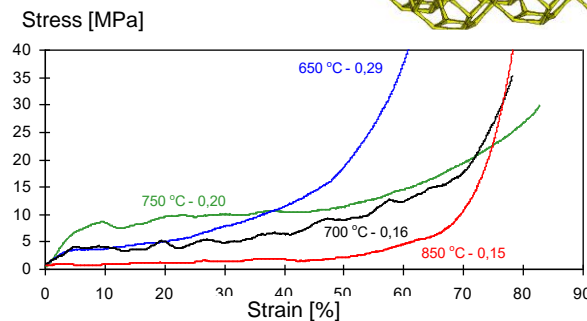
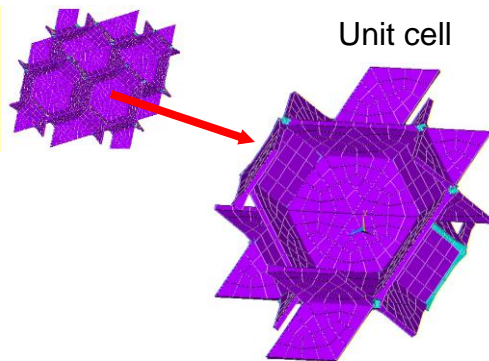
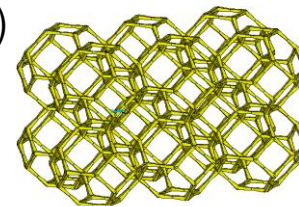

## Division of Strength of Materials and Structures – Research Areas

### Composites, cellular solids, smart and intelligent materials

- **NANOCOMPOSITES: PARAMETRIC FE MODELLING OF MECHANICAL, ELECTRICAL AND THERMAL PROPERTIES OF NANOCOMPOSITE**

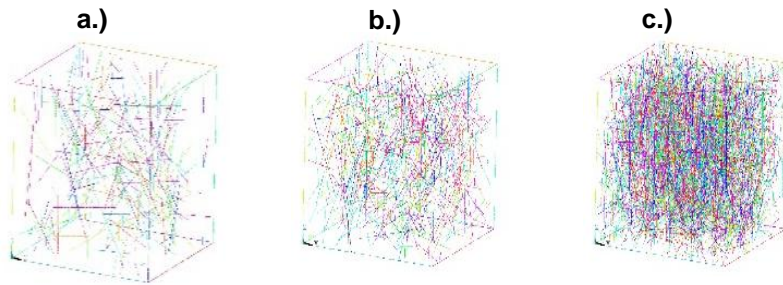

Models with different number of CNTs: a.) 200, b.) 500, c.) 2000.

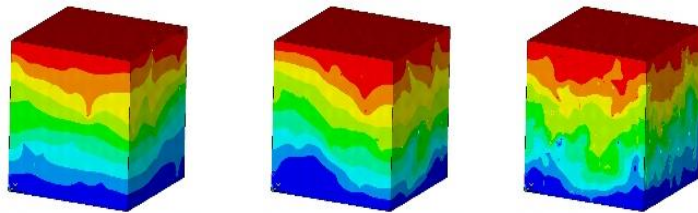

Potential [V] distribution for different number of CNTs.

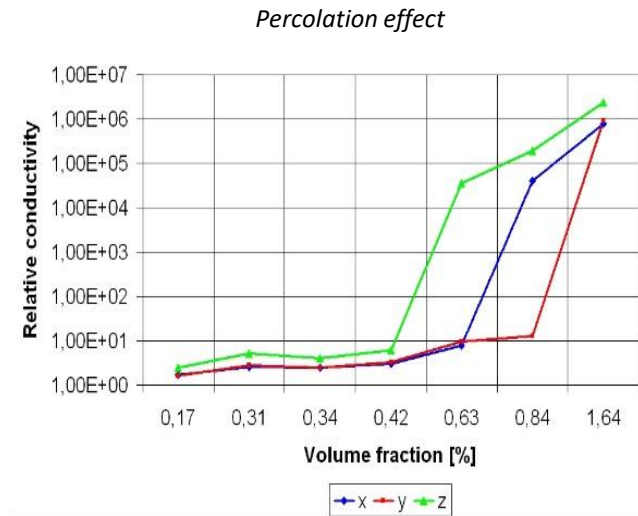

# Division of Strength of Materials and Structures – Research Areas

## Mechanics of solids

- FE MODELING OF MICROSCALE STRUCTURES WITH NON-UNIFORM MATERIAL DISTRIBUTION - CRYSTALLITES (NON-LINEAR MATERIAL PROPERTIES, LARGE DEFORMATION AND STRAIN)

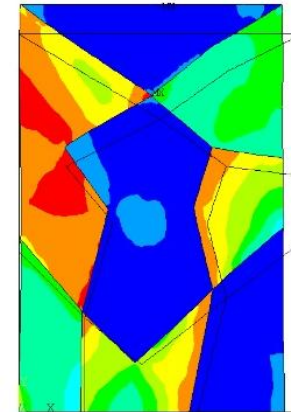
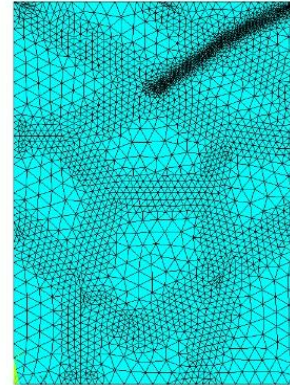
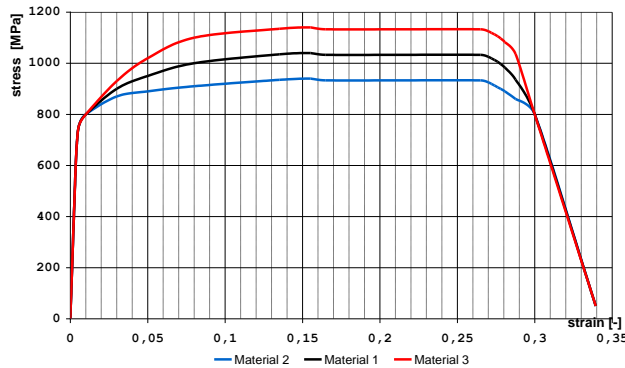

Equivalent stress distribution for 4.6% of total elongation

- SEQUENCE OF DAMAGE EVENTS (DELAMINATION) OCCURRING IN THE COURSE OF LOW ENERGY IMPACT OF CARBON FIBRE COMPOSITES

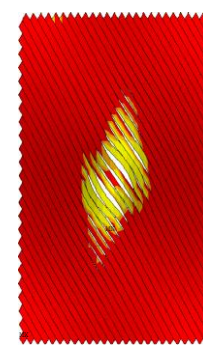
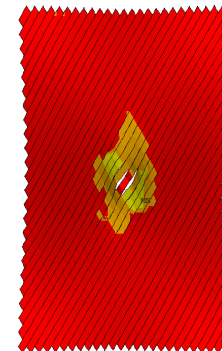
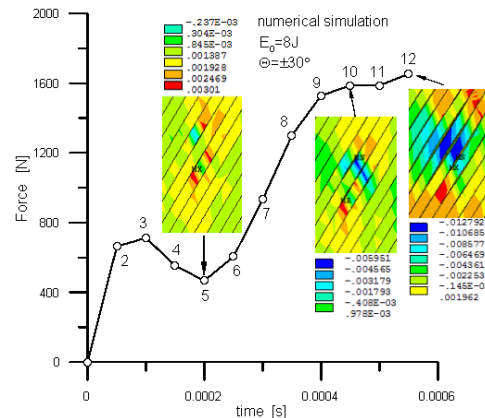
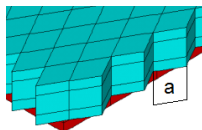
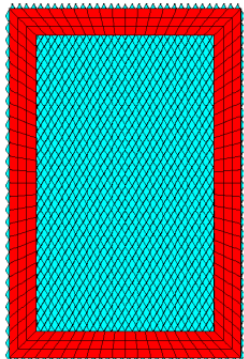

Final intra and interlaminar damage